

## VF35P



<b>Total volume</b> Capacità totale	35 lt.
<b>Net weight</b> Peso netto	19,5 kg.
<b>Power supply</b> Alimentazione	12/24 Vdc 100-240Vac 50/60Hz
<b>Absorption</b> Consumo	N.A.



Internal view - vista dell'interno

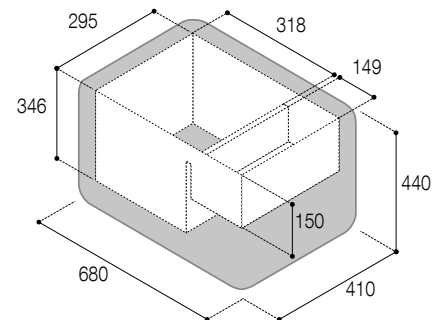
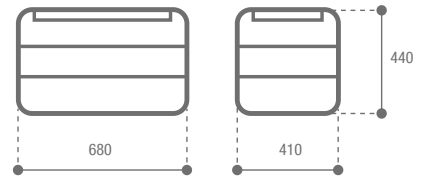

shoulder bag - tracolla  
external power supply - alimentatore esterno 100-240Vac 50/60Hz



Power supply cable - Cavi per il collegamento alla rete elettrica

