

# OVERTRUCK

**VITRIFRIGO**  
COOL AND BEYOND

MADE IN ITALY



Vitrifigo reserves the right to make any changes deemed appropriate for technical or commercial reasons at any time and without prior notice.

Vitrifigo si riserva il diritto di inserire in qualsiasi momento, e senza obbligo di preavviso, tutte le modifiche considerate opportune per ragioni tecniche o commerciali.

# OVERTRUCK

## STRATOS

Rooftop air conditioner  
for stationary use

*Climatizzatore da tetto  
ad uso stazionario*

04



## CHROMELOCK SERIES

Fridges and freezers with  
internal/External Cooling Unit

*Frigoriferi e freezer  
con unità interna/esterna*

10



## SPECIAL INSTALLATIONS

Compact drawer  
fridges and freezers

*Frigoriferi e freezers  
compatti a cassetto*

14

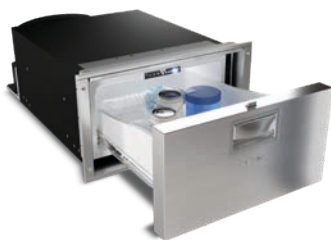

## PORTABLES

Portables fridges  
and freezers

*Frigoriferi e freezers  
portatili*

18



## TECHNICAL

Technical drawings  
*Disegni tecnici*

32

## CODE

Code chart  
*Legenda codici*

35

# STRATOS



# STRATOS

## ROOFTOP AIR CONDITIONER FOR STATIONARY USE



ITALIAN DESIGN



2 BLOCKS  
DESIGN



HIGH COOLING  
POWER



ADVANCED



TROPICAL  
USE



IP59  
CERTIFIED



LIFETIME  
TESTED



ENERGY  
SAVING



EXTREME  
TILT



EMC  
CERTIFIED



EASY  
FIX

# STRATOS

## CLIMATIZZATORE DA TETTO AD USO STAZIONARIO

# STRATOS

### Superior Comfort, Safety and Efficiency

COMFORT, SICUREZZA ED EFFICIENZA  
DI LIVELLO SUPERIORE

The new STRATOS rooftop air conditioner provides solutions for virtually any industrial vehicle currently on the road. Designed for maximum efficiency and minimum consumption, it is the best solution for air conditioning requirements in the driver's cab.

Vitrifrigo air conditioners, powered directly by the vehicle battery, guarantee the perfect compromise between energy saving and improved comfort conditions in terms of internal air conditioning quality, dehumidification and sound emissions.

They are simple to use with flexible air flow through individually adjustable air vents which can be easily managed by the integrated control panel or remote control.

Il nuovo climatizzatore da tetto STRATOS offre soluzioni adatte praticamente a qualsiasi automezzo industriale attualmente in circolazione. Progettato per ottenere la massima efficienza e il minor consumo, rappresenta la risposta più valida alle esigenze di condizionamento all'interno della cabina guida. I climatizzatori Vitrifrigo, alimentati direttamente dalla batterie del veicolo, garantiscono il perfetto compromesso tra ridotto consumo energetico e incremento delle condizioni di benessere, inteso sia come qualità della climatizzazione e della deumidificazione interna che come livello di emissioni di rumore.

Semplici nel loro utilizzo, con flussi d'aria flessibili attraverso diffusori ruotabili singolarmente, possono essere gestiti comodamente dal pannello di controllo integrato o mediante controllo remoto.



## Innovative Made in Italy Design

DESIGN INNOVATIVO MADE IN ITALY

### A STRONG PERSONALITY WITH A MODERN AND ELEGANT STYLE.

Stratos uses a new self-supporting chassis and storm-proof cover: the front profile line and the reduced height favour a perfect aerodynamic penetration, thus enabling to increase fuel efficiency. Thanks to last generation compressor with inverter technology stratos offers an high efficiency and reduced power consumption. Lifetime tested, Stratos is very fast and easy to install: you can fix it in extreme tilt (up to 30°).

### PERSONALITÀ DECISA, DESIGN MODERNO ED ELEGANTE.

Stratos utilizza un nuovo telaio autoportante con copertura a prova di intemperie: la linea del profilo anteriore e l'altezza ridotta favoriscono una perfetta penetrazione aerodinamica, consentendo così un deciso risparmio dei consumi di carburante. Il nuovo compressore di ultima generazione con tecnologia a inverter offre un'elevata efficienza e consumi ridotti. Testato a vita, Stratos si installa in maniera semplice e veloce, anche in situazioni in cui sia necessaria un'inclinazione decisamente elevata (fino a 30°).



### Advanced Features

CARATTERISTICHE AVANZATE

Temperature setting Regolazione temperatura	●
Blower speed setting levels Livelli di regolazione velocità ventilatori	6
Operation settings: AUTO, ECO, NIGHT Programmi di regolazione potenza: AUTO, ECO, NIGHT	3
On/off switching timer Timer accensione e spegnimento	●
Auto-diagnostic function Funzione di autodiagnostica	●

# STRATOS

Battery saving function Funzione salva batteria	●
Tilting sensor Sensore di spegnimento con cabina inclinata	●
Compressor type Tipo di compressore	24Vdc Inverter Rotary/Rotativo
Max cooling capacity Resa frigorifera max	6000 Btu/h
Round adjustable diffusers Bocchette aria orientabili	●



## Fast and Easy Installation

INSTALLAZIONE SEMPLICE E VELOCE

The Stratos is equipped with a self-supporting plastic platform designed to be installed on most popular truck brands.

- (1) After removing the roof hatch, the unit is ready to be installed together with its installation kit.
- (2) Install Stratos on the truck roof.
- (3) Set the supplied flange for completing the internal installation.

Stratos è dotato di un pianale portante in materiale plastico predisposto per essere montato sui camion dei marchi più diffusi.

- (1) Dopo aver rimosso la botola, è già possibile predisporre il pianale secondo le istruzioni del kit dedicato.
- (2) Installare Stratos sul tetto del camion.
- (3) Montare la cornice in dotazione per completare l'installazione.

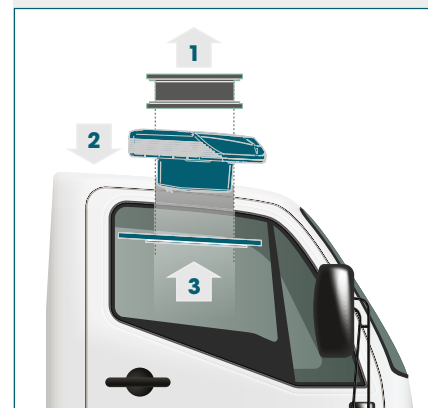

## Remote Control

TELECOMANDO

Small size remote control with auto time set function for timed on/off switching. By using the Stratos remote control, you can quickly access to the all functions. You can choose AUTO, ECO, NIGHT functioning mode:

3 single settings to get the best:

- Auto: max performance (up to 1750 W)
- Eco: max operating time (more than 14 hrs)
- Night: very low noise level.

Telecomando di ridotte dimensioni con funzione di accensione/spengimento temporizzato, mediante il quale è possibile accedere rapidamente a tutte le funzioni dello Stratos, selezionando così una delle 3 modalità di funzionamento preimpostate:

- Auto: massimo della potenza (fino a 1750W)
- Eco: massimo della durata (oltre 14 ore)
- Night: massimo della silenziosità.



- 1** On/off  
Accensione/spengimento
- 2** Temperature control  
Controllo temperatura
- 3** Menu  
Menu
- 4** Timer  
Timer
- 5** Compressor power  
Potenza del compressore
- 6** Fan speed  
Velocità dei ventilatori



## Oled Display

DISPLAY OLED

### BRIGHT AND EASY TO USE OLED DISPLAY.

Stratos fits into the vehicle cabin in a discreet and elegant way: the anthracite gray casing houses the three adjustable vents to distribute the air flow as desired, the internal air intake grille and the new high-brightness OLED display able to set the desired functions.

### DISPLAY OLED LUMINOSO E DI SEMPLICE UTILIZZO.

Stratos si inserisce nella cabina del veicolo in maniera discreta ed elegante: l'involucro grigio antracite ospita le tre bocchette orientabili per distribuire a piacere il flusso dell'aria, il grigliato di aspirazione dell'aria interna e il nuovo display oled ad alta luminosità con il quale impostare le funzioni desiderate.



## KIT STRATOS

Cod.	BRAND	MODEL + CABIN	Year
0802-0008	DAF	XF SPACE CAB	(XF106) 2013-2021
0802-0002	DAF	XF SUPER SPACE CAB	(XF106) 2013-2021
0802-0135	DAF	NEW XF/XG/XG+	2021-->
0802-0009	IVECO	STRALIS HI-ROAD	2012-2019
0802-0004	IVECO	STRALIS HI-WAY - S-WAY cab. AT/AD	2012-2019
0802-0215	IVECO	S-WAY cab. AS	2019-->
0802-0010	MERCEDES	ACTROS MP4/MP5	(MP4) 2011-2018 - (MP5) 2018-->
0802-0012	RENAULT	T SERIES	2013-->
0802-0001	SCANIA	R SERIES	2004-2016
0802-0079	SCANIA	NEXT GENERATION	2016-->
0802-0007	MAN	TGX	2007-2020
0802-0183	MAN	NEW TGX	2020-->
0802-0219	FORD	F-MAX	2018-->
0802-0221	VOLVO	FH SERIES 4	2020-->
0802-0003	UNIVERSALE		

\* The availability of kits is constantly in progress due to the update of models from various brands. For more information, please contact us at: [sales@vitrifigo.com](mailto:sales@vitrifigo.com)  
 La disponibilità dei kit è in continua evoluzione a seguito dell'aggiornamento dei modelli dei vari brand. Per maggiori informazioni contattateci a:

# STRATOS



Cooling capacity  
Potenza frigorifera 6.000 Btu/h.

Net weight  
Peso netto 22,5 kg.

Power supply  
Alimentazione 24 Vdc

Refrigerant gas  
Gas refrigerante R134a

Rotary air openings  
Bocchette orientabili N.3

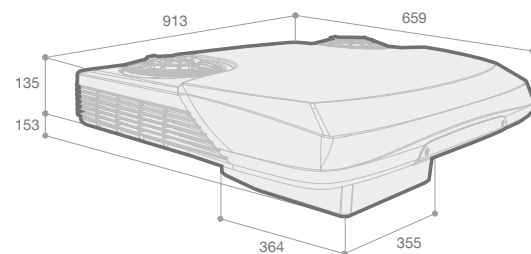
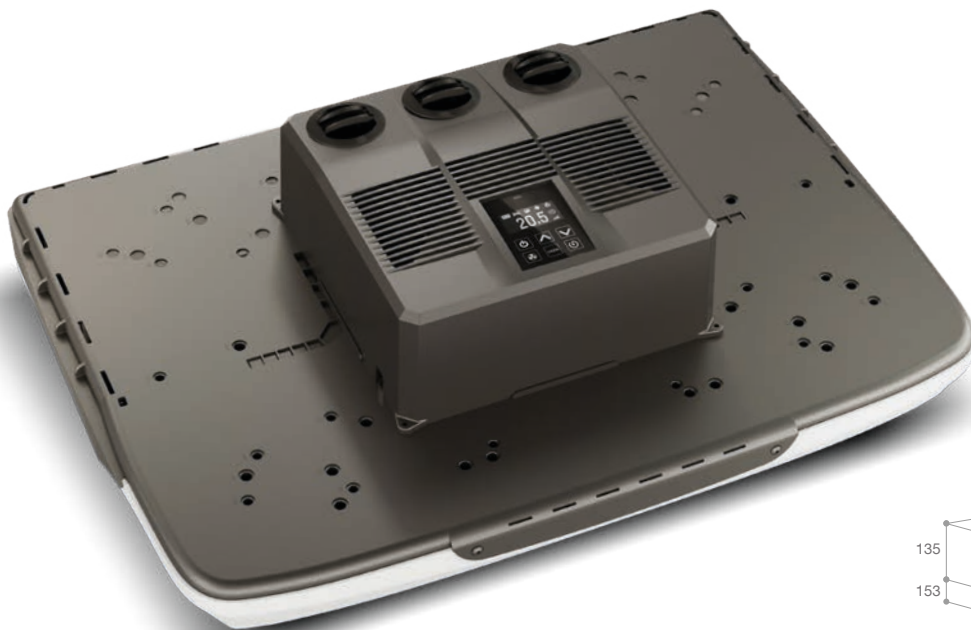

# CHROMELOCK SERIES



## Double door finishing

DOPPIA COLORAZIONE DELLA PORTA



## Door Inside or Outside

PORTA A FILO INTERNO O ESTERNO



### BLACK

Black matte soft touch panel.  
Pannello nero opaco effetto soft touch



### LIGHT GREY

Light grey glossy panel.  
Pannello grigio perla effetto lucido



## Replaceable Finish Panel

PANNELLO DI FINITURA SOSTITUIBILE

Finishing panels from 0.8 mm to 3.0 mm thick.

Pannelli di finitura con spessori da 0,8 a 3,0 mm.



## Integrated Vent Position

VENTILAZIONE INTEGRATA

Holds the door ajar during periods of non-use.

Mantiene la porta socchiusa nei periodi di non utilizzo.



## FRIDGES AND FREEZERS

with Internal/External Cooling Unit

## FRIGORIFERI E FREEZER

CON UNITÀ INTERNA/ESTERNA



FRIDGE + FREEZER  
FRIGO + FREEZER



FRIDGE  
FRIGO



DRAWER  
CASSETTO



### Removable basket

CESTELLO AMOVIBILE

Drawer models are equipped with a removable additional basket to maximize beverage storage.

Le versioni a cassetto sono dotate di un cestello estraibile per massimizzare la conservazione delle bevande.



Optional



### Power Supply

ALIMENTATORE  
115-230Vac 50/60Hz 24Vdc



300W



150W



### Internal fixing points

PUNTI DI FISSAGGIO INTERNI

Attachment to the recessed compartment from the inside (selected models).

Fissaggio al vano d'incasso dall'interno (modelli selezionati).



### Internal LED light

LUCE INTERNA A LED

Internal LED lighting with high brightness and minimum consumption.

Illuminazione interna a LED ad elevata luminosità e consumi minimi.

Available models Modelli disponibili	Total volume Capacità totale			
		LT.		
C62i CHR	62	■		
C62DWi CHR	62	■		■
C60i CHR	60	■	□	
C51i CHR	51	■		
C51DWi CHR	51	■		■
C50i CHR	50	■	□	
C42L CHR	42	■	□	
C42DWL CHR	42	■	□	■
C39i CHR	39	■	□	

Fridge/Freezer  
Frigo/Congelatore

■ Standard  
□ Optional

Fridge  
Frigo

Drawer  
Cassetto

### Removable Cooling Unit

UNITÀ DI REFRIGERAZIONE REMOTABILE

**UP TO 1,5 mt.** More volume inside the fridge and more installation options.

**FINO A 1,5 mt.** Maggior volume all'interno del frigorifero e maggiori opzioni di installazione.

C62i CHR  
Internal Cooling Unit - R600a Compressor



C62DWi CHR  
Internal Cooling Unit - R600a Compressor



H max  
250 mm.

C60i CHR  
Internal Cooling Unit - R600a Compressor



**C51i CHR**Internal Cooling Unit - **R600a** Compressor**C51DWi CHR**Internal Cooling Unit - **R600a** CompressorH max  
250 mm.**C50i CHR**Internal Cooling Unit - **R600a** Compressor**C42L CHR****R600a** Compressor

External Cooling Unit

**C42DWL CHR****R600a** CompressorH max  
250 mm.**C39i CHR**Internal Cooling Unit - **R600a** Compressor

	C62i CHR	C62DWi CHR	C60i CHR	C51i CHR	C51DWi CHR	C50i CHR	C42L CHR	C42DWL CHR	C39i CHR
Total volume (lt.) Capacità totale	62	62	60	51	51	50	42	42	39
Freezer compartment (lt.) Comparto Freezer	4,5	4,5	10,2	3,6	3,6	3,6	3,6	3,6	3,6
12-24 Vdc (Standard)	•	•	•	•	•	•	•	•	•
115-230Vac 50/60Hz (Optional)	•	•	•	•	•	•	•	•	•
Absorption (Wh/24h) Consumo	N.A.	N.A.	520	N.A.	N.A.	N.A.	240	240	250
Net weight (kg.) Peso	16,8	19,5	18,6	18	21	18	15	18	16
Dimensions (mm.) Dimensioni	A 450	450	470	380	380	396	380	380	390
	B 542	542	457	514	514	397	384	384	397
	H 530	530	622	532	532	636	532	532	547



# SPECIAL INSTALLATION

**NEW** THE RANGE  
IS WIDENING

WHEN A NORMAL SOLUTION  
WOULD NOT FIT...

LA GAMMA  
SI AMPLIA

QUANDO UN FRIGO  
NORMALE NON PUÒ  
ESSERE INSTALLATO...



4 sided low height  
fitting flange  
included

flangia di fissaggio  
a 4 lati ad altezza  
ridotta inclusa



Drawer color of your choice  
COLORE DEL CASSETTO A SCELTA

D20A and D30A are available with a stainless steel door or with a white or black finish.

Thanks to commercial agreements, the refrigerator door color can be customized with any chosen shade, allowing the product to blend seamlessly into the surrounding decor.

D20A e D30A sono disponibili con porta in acciaio inox, oppure con finitura bianca o nera. In virtù di accordi commerciali, il colore della porta del frigorifero può essere personalizzato con qualsiasi tonalità prescelta, permettendo al prodotto di integrarsi perfettamente nell'arredamento circostante.

**HP** NextGen  
Compressor  R600a

 **Tailor made for mobile cooling**  
Specifico per la refrigerazione mobile

 **Low noise and vibrations**  
Silenzioso e basse vibrazioni

For further information, see page 6  
Per ulteriori informazioni, si veda la pag. 6

**Remotable Cooling Unit**  
UNITÀ DI REFRIGERAZIONE REMOTABILE

**UP TO 1,5 mt.** More volume inside the fridge and more installation possibilities.

**FINO A 1,5 mt.** Maggior volume all'interno del frigorifero e maggiori possibilità di installazione.



Sport Grey version

Color available for both  
D20A HP and D30A HP  
Colore disponibile sia per  
D20A HP che per D30A HP

## COMPACT DRAWER REFRIGERATORS AND FREEZERS

## FRIGORIFERI E FREEZER COMPATTI A CASSETTO

### Electronic LED thermostat

TERMOSTATO ELETTRONICO A LED



Very low noise and  
high energy savings

Silenziosità assoluta e  
risparmio energetico



NIGHT  
MODE



FREEZER  
MODE

OPTIONAL



### Door Inside Door Outside

Fitting flange (optional), which by simply sliding it, allows both the totally built-in version (door inside) and the partially built-in version (door outside).

Profilo di fissaggio (optional), che permette tramite scorrimento sia la versione a incasso totale (door inside) che quella a incasso parziale (door outside).

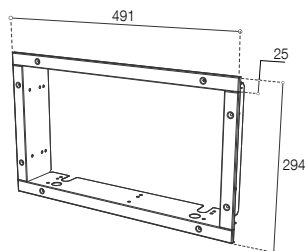

Available models  
Modelli disponibili

Total volume  
Capacità totale

Available models Modelli disponibili	Total volume Capacità totale	
	LT.	
D30AX HP	30	
D30A HP	30	
D20AX HP	20	
D20A HP	20	
C47	47	
V31	31	<b>VOLVO</b>
S44	44	<b>SCANIA</b>
C25LP	25	

## D30AX HP



## D30A HP



**R600a**  
Next Gen  
Compressor



H max  
155 mm.

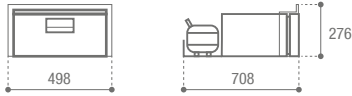

## D20AX HP



## D20A HP



**R600a**  
Next Gen  
Compressor



H max  
155 mm.



		D30AX HP	D30A HP	D20AX HP	D20A HP
Total volume Capacità totale	(lt.)	30	30	20	20
Net weight Peso netto	(kg.)	17	14	15	12
Power supply Alimentazione	(Vdc)	12/24	12/24	12/24	12/24
Absorption Consumo	(Wh/24h)	241	241	150	150

Optional



**Power Supply**  
ALIMENTATORE

115-230Vac  
50/60Hz  
24Vdc



300W



150W

❄️ -6°C

❄️❄️ -12°C

❄️❄️❄️ -18°C

N Class: 16/32°C • ST Class: 16/38°C • T Class: 16/43°C

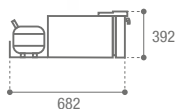
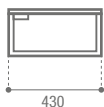
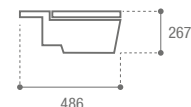
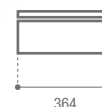
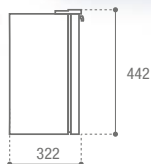
**C47**Internal Cooling Unit  
**R600a** Compressor**Volvo****V31**Internal Cooling Unit  
**R134a** CompressorRemovable lid  
Coperchio amovibile**C25LP****R600a** CompressorFridge  
Frigido

External Cooling Unit

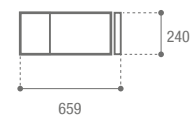
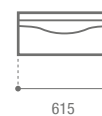
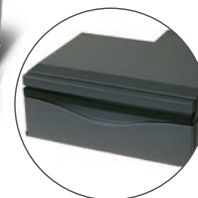
**Scania****S44**Internal Cooling Unit  
**R134a** Compressor

		C47	V31	S44	C25LP
Total volume Capacità totale	(lt.)	47	31	44	25
Net weight Peso netto	(kg.)	19	16	16	12
Power supply Alimentazione	(Vdc)	12/24	12/24	12/24	12/24
Absorption Consumo	(Wh/24h)	285	614	445	420

Optional

Power  
Pack**Power Supply**  
ALIMENTATORE115-230Vac  
50/60Hz  
24Vdc

300W



150W

# PORTABLE



## Organize your free time

### ORGANIZZATE IL VOSTRO TEMPO LIBERO

Portable refrigerators are equipped with a removable coated wire basket, useful for easily loading and removing food and drinks.

The standard locking bracket allows to keep the refrigerator in place while underway (except for C65).

A 12Vdc cord is supplied for connecting the refrigerator to the car battery.

I frigoriferi portatili sono dotati di serie di un pratico cestello interno removibile a fili d'acciaio, estremamente utile per introdurre o estrarre facilmente tutto il contenuto del frigorifero.

La staffa di fissaggio in dotazione standard dà la possibilità di ancorare saldamente e velocemente il frigorifero in uno spazio predeterminato (eccetto C65).

In dotazione anche il cavo per l'alimentazione a batteria, con la presa universale per l'accendisigari.

Removable basket - Cestello removibile



Locking bracket - Staffa di fissaggio



12Vdc plug - Presa per alimentazione a 12 Vdc



Internal led light - Luce interna a Led



## PORTABLE REFRIGERATORS AND FREEZERS

## PORTATILI FRIGORIFERI E FREEZER



Available models Modelli disponibili	Total volume Capacità totale
---	---------------------------------

C65L - C65D	65 lt.
C29M - C29D	29 lt.

### VFREE SERIES

VF65P	65 lt.
VF55P	55 lt.
VF45P	45 lt.
VF35P	35 lt.
VF16P	16 lt.

### VFREE PLUS SERIES

VFT60	60 lt.
VFT50	50 lt.
VFT40	40 lt.
VFT30	30 lt.
VFP60	60 lt.
VFP50	50 lt.
VFP40	40 lt.
VFD115	115 lt.
VFD95	95 lt.
VFC15	15 lt.

## Temperature under control

### TEMPERATURA SOTTO CONTROLLO

Depending on the type of portable refrigerator, you can choose the solution that best suits your personal needs, to keep the internal temperature of the refrigerator constantly monitored.

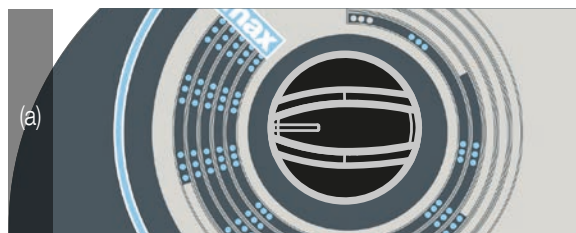

A seconda della tipologia di frigorifero portatile è possibile scegliere la soluzione che più si addice alle esigenze personali, per mantenere la temperatura interna del frigorifero costantemente monitorata.



(a) Mechanical thermostat  
Termostato meccanico

(b) Electronic LED thermostat  
Termostato elettronico a LED

(c) Digital thermostat  
Termostato digitale





C65L - C65D

Total volume  
Capacità totale 65 lt.

Net weight  
Peso netto 24 kg.

Power supply  
Alimentazione STANDARD 12-24 Vdc  
OPTIONAL 12-24 Vdc  
115-230Vac  
50/60Hz

Absorption  
Consumo N.A.

C65L Electronic LED thermostat  
Termostato elettronico a LED

C65D Digital thermostat  
Termostato digitale

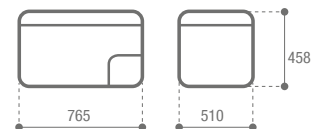



°C + 10 - 15

C29M - C29D

Total volume Capacità totale	29 lt.
Net weight Peso netto	15 kg.
Power supply Alimentazione	STANDARD 12-24 Vdc OPTIONAL 12-24 Vdc 115-230Vac 50/60Hz
Absorption Consumo	N.A.

C29M - Mech. thermostat - Termostato mecc.

C29D - Digital thermostat - Termostato digitale

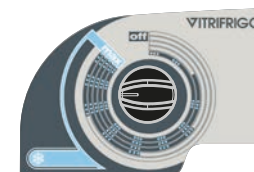
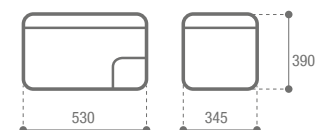

C29M

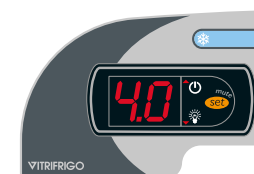

C29D

C29D is  
available  
only as

C29D è  
disponibile  
solo in versione

12-24 Vdc 115-230Vac 50/60Hz

# PORTABLE VFREE SERIES



All the capacity you need

TUTTA LA CAPIENZA CHE TI SERVE



VF35P - VF45P  
VF55P - VF65P



VF16P



Precise and total control

CONTROLLO PRECISO E TOTALE



The temperature set points are shown on the high brightness digital display.

An USB port is available for a direct power supply and for the charging of devices such as smartphones, tablets, etc.

The "Emergency override" function automatically blocks the thermostat in the event of a malfunction, allowing the fridge to operate in complete autonomy.

Display digitale ad alta luminosità con visualizzazione dei set point della temperatura.

Disponibile la presa USB per l'alimentazione e la ricarica diretta di dispositivi quali smartphone, tablet, ecc. Funzione "Emergency override" che blocca automaticamente il termostato in caso di malfunzionamento, lasciando che il frigo funzioni in completa autonomia.

## PORTABLE REFRIGERATORS AND FREEZERS

## PORTATILI FRIGORIFERI E FREEZER



The VFREE series has been designed to offer maximum practicality in daily use:

- two sturdy handles facilitate lifting and transportation (the VF16P is equipped with a handy strap for carrying on the shoulder);
- the lid can be opened on both sides and, if necessary, is completely removable (with the exception of the VF16P);
- the basket is removable and its internal volume can be compartmentalised to optimise the storage of food and drinks (with the exception of the VF16P);
- a wide range of usable power supplies: from 12-24 Vdc to 100-240Vac 50/60Hz;
- the interior lighting with high brightness blue LEDs allows use of the fridge in situations of complete darkness.

La serie VFREE è stata pensata per offrire il massimo della praticità nell'utilizzo quotidiano:

- due robusti maniglioni agevolano il sollevamento e il trasporto (il VF16P ha in dotazione una tracolla per il trasporto a spalla);
- il coperchio è apribile da entrambi i lati e, all'occorrenza, completamente amovibile (ad eccezione del VF16P);
- il cestello è estraibile e il suo volume interno divisibile per ottimizzare lo stivaggio di cibo e bevande (ad eccezione del VF16P);
- un ampio range di alimentazioni utilizzabili: da 12-24 Vdc a 100-240Vac 50/60Hz;
- l'illuminazione interna a led azzurrati ad alta luminosità consente l'utilizzo del frigo in situazioni di totale assenza di luce.



Power supply cable  
Cavi per il collegamento alla rete elettrica



External power supply  
Alimentatore esterno  
(115-230Vac 50/60Hz)

Shoulder bag  
Tracolla





°C + 10 - 22

VF65P

Total volume Capacità totale	65 lt.
Net weight Peso netto	23 kg.
Power supply Alimentazione	12-24 Vdc 115-230Vac 50/60Hz
Absorption Consumo	N.A.



°C + 10 - 22

VF55P

Total volume Capacità totale	55 lt.
Net weight Peso netto	22 kg.
Power supply Alimentazione	12-24 Vdc 115-230Vac 50/60Hz
Absorption Consumo	N.A.





°C + 10 - 22

VF45P

Total volume Capacità totale	45 lt.
Net weight Peso netto	20,5 kg.
Power supply Alimentazione	12-24 Vdc 115-230Vac 50/60Hz
Absorption Consumo	N.A.



°C + 10 - 22

VF35P

Total volume Capacità totale	35 lt.
Net weight Peso netto	19,5 kg.
Power supply Alimentazione	12-24 Vdc 115-230Vac 50/60Hz
Absorption Consumo	N.A.



°C + 10 - 18

VF16P

Total volume Capacità totale	16 lt.
Net weight Peso netto	8 kg.
Power supply Alimentazione	12-24 Vdc 115-230Vac 50/60Hz (*)
Absorption Consumo	N.A.

(\*) with external power supply / con alimentatore esterno

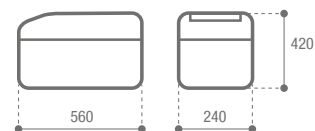

# PORTABLE VFREE PLUS SERIES



SMART APP CONTROL



## External power supply ALIMENTATORE ESTERNO

115-230Vac external Power Supply. Automatic switchover from tension mains (AC) to battery.

Alimentatore esterno 115-230Vac. Commutazione automatica da tensione di rete alternata (CA) a tensione di batteria (CC).



12-24 Vdc Car Cigarette Lighter Socket Plug Connector

Presa per il collegamento all'accendisigari dell'auto (12-24 Vdc).



- A** Detachable lithium ion battery (OPTIONAL)  
Batteria agli ioni di litio rimovibile
- B** 12-24Vdc 115-230Vac 50/60Hz for indoor/outdoor  
12-24Vdc 115-230Vac 50/60Hz per uso interno/esterno
- C** Detachable lid with integrated cutting board  
Coperchio amovibile con tagliere interno
- D** High brightness white LED light (except for VFC15-VFT30)  
Luce LED bianca ad alta luminosità (eccetto VFC15-VFT30)
- E** Anti-shake/vibration and incline operation up to 45° angle in short time  
Funzionamento antivibrante con inclinazioni fino a 45° in breve tempo

## Precise and total control CONTROLLO PRECISO E TOTALE



The digital panel manages temperature and functions. It includes a USB port for device charging and a smart battery protection system with automatic voltage monitoring.

Il pannello digitale gestisce temperatura e funzioni. Include una presa USB per ricaricare dispositivi e un sistema intelligente che previene lo scaricamento della batteria monitorando automaticamente il voltaggio.

## PORTABLE REFRIGERATORS AND FREEZERS

## PORTATILI FRIGORIFERI E FREEZER



Dual compartment with individual temperature control



Doppio compartimento con temperature indipendenti

Internal removable basket (VFD series only)

Cestello interno removibile (Solo serie VFD)

Sturdy telescoping handle

Robusto manico telescopico

Big wheels

Ruote grandi

## OPTIONAL

### Slides

GUIDE SCORREVOLI  
eccetto/except for:  
VFC15-VFD115



### Detachable lithium ion battery BATTERIA AGLI IONI DI LITIO RIMOVIBILE



15.600mAh

It can keep 4-6 hours of battery life for outdoor use.

In grado di garantire un'autonomia di 4-6 ore in uso esterno.

### 100/200W Solar Panel 19,5 Vdc 5,5A



### Foldable solar panel bag BORSA PIEGHEVOLE PER PANNELLI SOLARI

Lightweight, portable, with stable output voltage and current, it is suitable for connecting multiple elements in parallel to increase the battery charging speed.

Leggera, portatile, con tensione e corrente stabile in uscita, è adatta al collegamento in parallelo di più elementi per aumentare la velocità di ricarica della batteria.



°C + 20 - 20

VFT60

Total volume Capacità totale	60 lt.
Net weight Peso netto	18,7 kg.
Power supply Alimentazione	12-24 Vdc 115-230Vac 50/60Hz
Absorption Consumo	232 Wh/24h

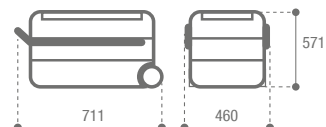

°C + 20 - 20

VFT50

Total volume Capacità totale	50 lt.
Net weight Peso netto	17,7 kg.
Power supply Alimentazione	12-24 Vdc 115-230Vac 50/60Hz
Absorption Consumo	227 Wh/24h

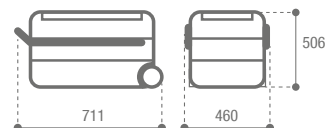

°C + 20 - 20

VFT40

Total volume Capacità totale	40 lt.
Net weight Peso netto	16,7 kg.
Power supply Alimentazione	12-24 Vdc 115-230Vac 50/60Hz
Absorption Consumo	221 Wh/24h

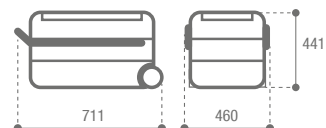



°C + 20 - 20

VFT30

Total volume Capacità totale	30 lt.
Net weight Peso netto	12,8 kg.
Power supply Alimentazione	12-24 Vdc 115-230Vac 50/60Hz
Absorption Consumo	268 Wh/24h

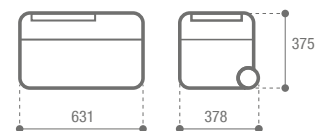

°C + 20 - 20

VFP60

Total volume Capacità totale	60 lt.
Net weight Peso netto	17,7 kg.
Power supply Alimentazione	12-24 Vdc 115-230Vac 50/60Hz
Absorption Consumo	232 Wh/24h

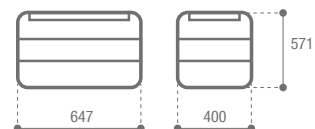

°C + 20 - 20

VFP50

Total volume Capacità totale	50 lt.
Net weight Peso netto	15,7 kg.
Power supply Alimentazione	12-24 Vdc 115-230Vac 50/60Hz
Absorption Consumo	227 Wh/24h





°C + 20 - 20

VFP40

Total volume Capacità totale	40 lt.
Net weight Peso netto	14,7 kg.
Power supply Alimentazione	12-24 Vdc 115-230Vac 50/60Hz
Absorption Consumo	221 Wh/24h



°C + 20 - 20

VFD115

Total volume Capacità totale	115 lt.
Net weight Peso netto	30,8 kg.
Power supply Alimentazione	12-24 Vdc 115-230Vac 50/60Hz
Absorption Consumo	295 Wh/24h

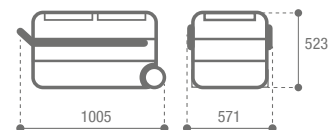

°C + 20 - 20

VFD95

Total volume Capacità totale	95 lt.
Net weight Peso netto	28 kg.
Power supply Alimentazione	12-24 Vdc 115-230Vac 50/60Hz
Absorption Consumo	268 Wh/24h

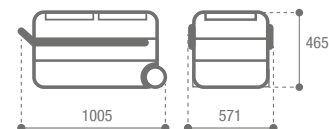

## ARMREST FRIDGE/FREEZER

FRIGO/FREEZER DA BRACCIOLO

°C + 20 - 18

VFC15

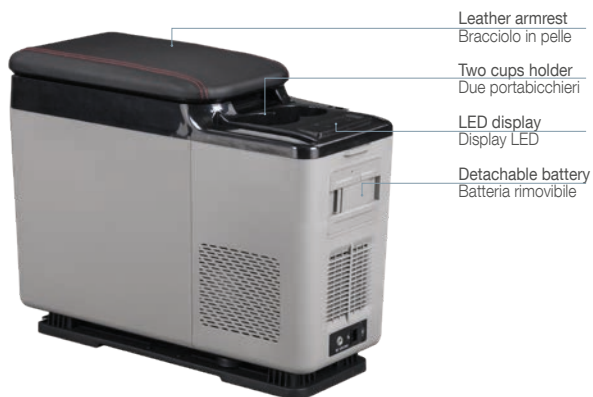

Total volume Capacità totale	15 lt.
Net weight Peso netto	9,3 kg.
Power supply Alimentazione	12-24 Vdc
Absorption Consumo	115-230Vac 50/60Hz 263 Wh/24h

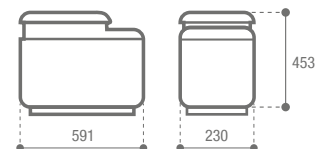

# TECHNICAL DRAWINGS

## DISEGNI TECNICI

CHROMELOCK SERIES

C62i CHR

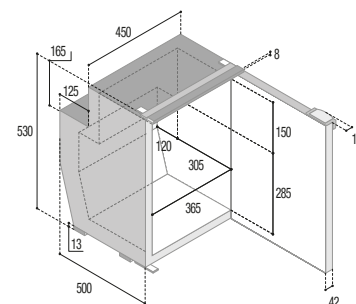

C62DWi CHR

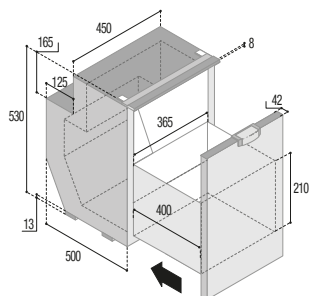

C60i CHR

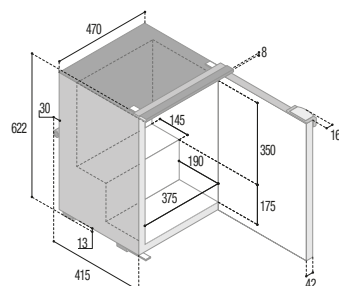

C51i CHR

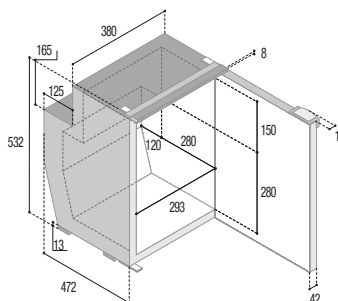

C51DWi CHR

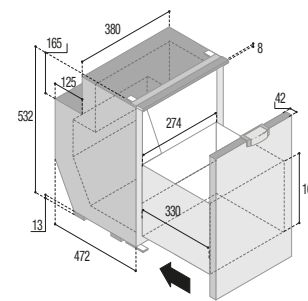

C50i CHR

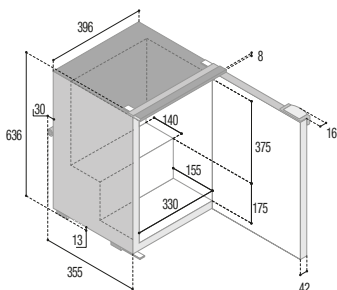

C42L CHR

 External Cooling Unit

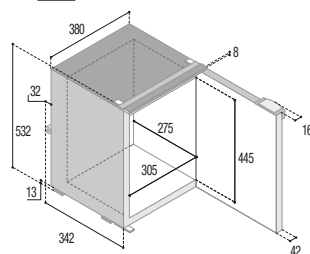

C42DWL CHR

 External Cooling Unit

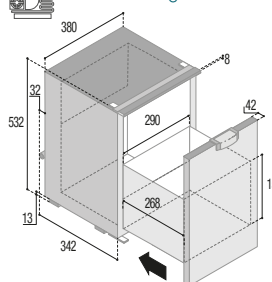

C39i CHR

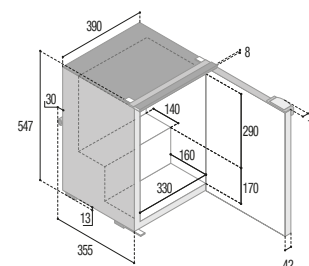

  
External  
Cooling Unit

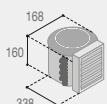

Door Inside | Door Outside

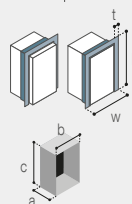

Mounting  
flange  
Profilo di  
fissaggio

Built-in  
Vano  
incasso

DOOR	C62i CHR		C62DWi CHR		C60i CHR		C51i CHR		C51DWi CHR		C50i CHR		C42L CHR		C42DWL CHR		C39i CHR	
	Inside	Outside	Inside	Outside	Inside	Outside	Inside	Outside	Inside	Outside	Inside	Outside	Inside	Outside	Inside	Outside	Inside	Outside
t:	25	25	25	25	25	25	25	25	25	25	25	25	25	25	25	25	25	25
w:	513	513	513	513	533	533	443	443	443	443	459	459	443	443	443	443	453	453
h:	542	542	542	542	634	634	544	544	544	544	649	649	544	544	544	544	559	559
a:	545	502	545	502	459	417	516	474	516	474	399	357	386	344	386	344	399	357
b:	468	468	468	468	488	488	398	398	398	398	414	414	398	398	398	398	408	408
c:	536	536	536	536	626	626	536	536	536	536	640	640	536	536	536	536	550	550

SPECIAL INSTALLATIONS SERIES

D30AX HP

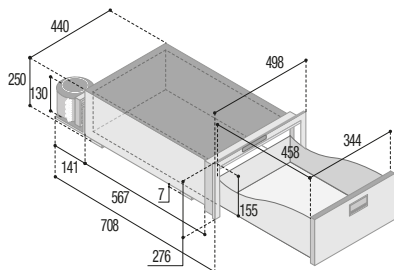

D30A HP

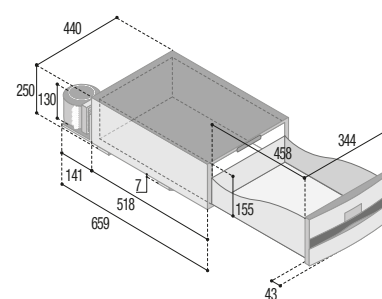

D20AX HP

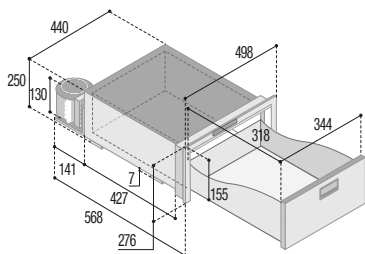

D20A HP

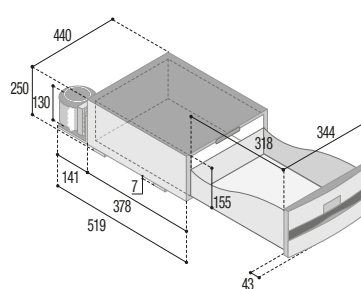

C47

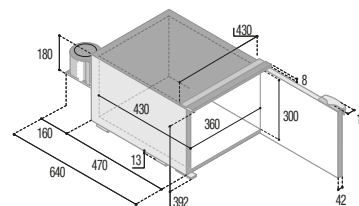

S44

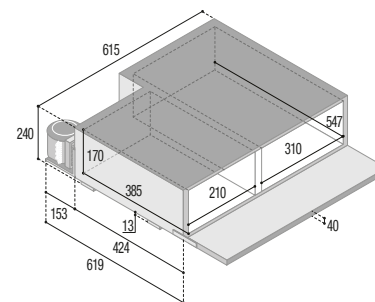

C25LP

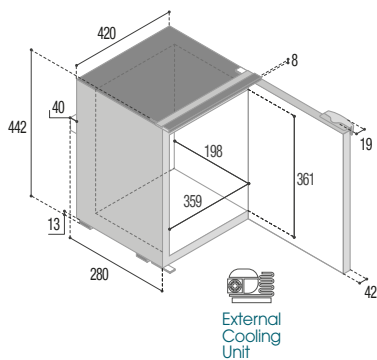

V31

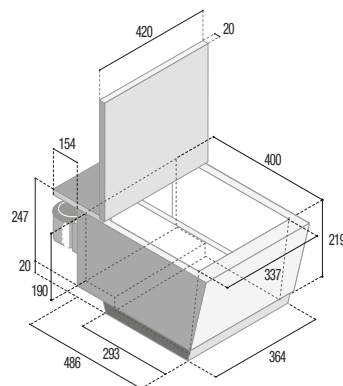

DOOR	C47		C25LP	
	Inside	Outside	Inside	Outside
t:	25	25	25	25
w:	493	493	484	484
h:	404	404	454	454
a:	683	640	322	280
b:	448	448	439	439
c:	395	395	433	433

PORTABLE SERIES

C65L - C65M

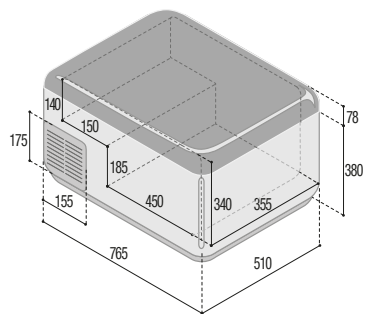

C29M - C29D

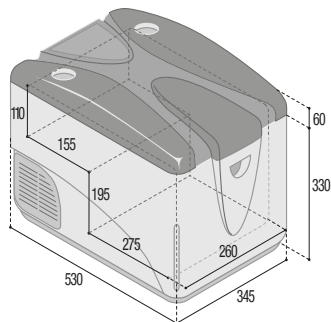

VF65P

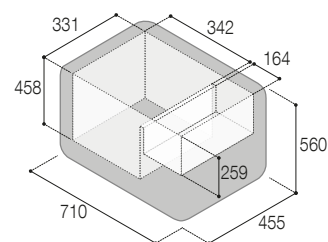

VF55P

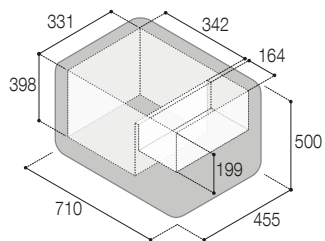

VF45P

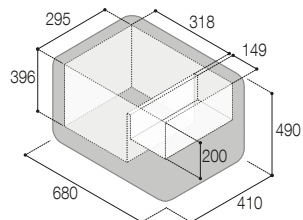

VF35P

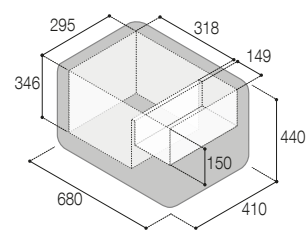

VF16P

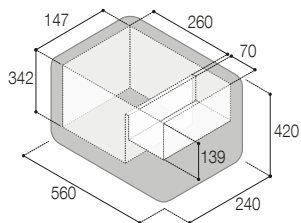

VFT60

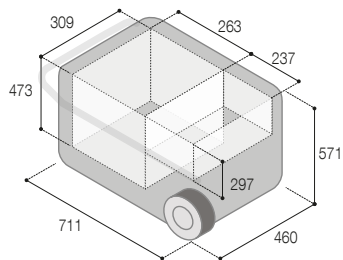

VFT50

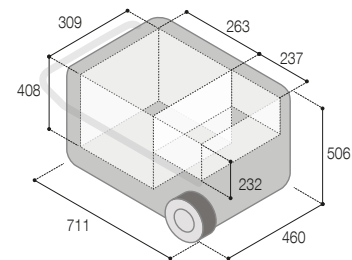

VFT40

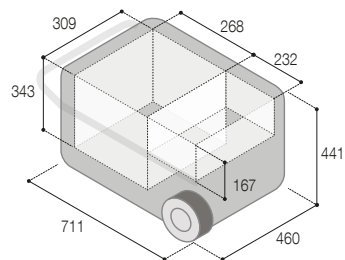

VFT30

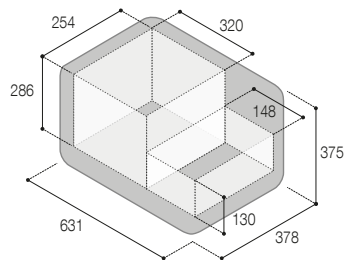

VFP60

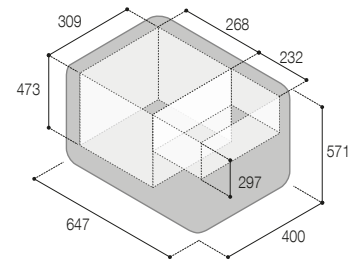

PORTABLE  
SERIES

VFP50

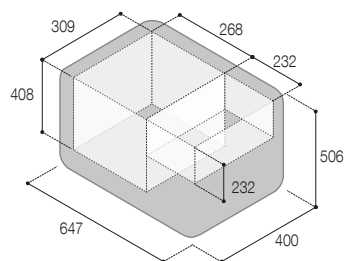

VFP40

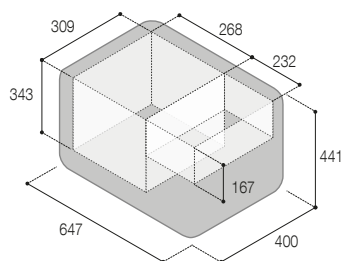

VFD115

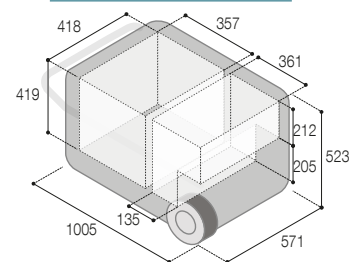

VFD95

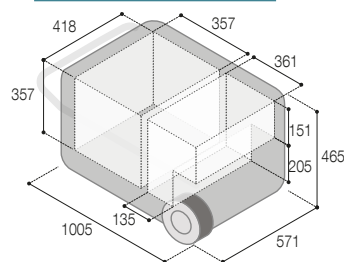

VFC15

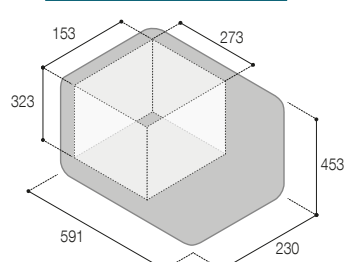
REFRIGERATORS AND FREEZERS  
WITH BUILT-IN/REMOTE UNIT

- C** fridges and freezers series with front door opening
- I** internal cooling unit version
- L** external cooling unit version
- DW** drawer version
- CHR** Chromelock series

PORTABLE AND SPECIAL INSTALLATION  
REFRIGERATORS

- C** fridges and freezers series with front door opening
- L** LED thermostat version
- D** digital thermostat version
- M** mechanical thermostat version
- P** BRK35 version with PUSH-PULL lock
- HP** refrigerators-freezers series with NextGen compressor

FRIGORIFERI E FREEZER  
CON UNITA' ESTERNA/INTERNA

- serie frigoriferi e freezer con apertura frontale
- versione con unità refrigerante interna
- versione con unità refrigerante esterna
- versione a cassetto
- serie Chromelock

FRIGORIFERI PORTATILI  
E PER INSTALLAZIONI SPECIALI

- serie frigoriferi e freezer con apertura frontale
- versione con termostato a LED
- versione con termostato digitale
- versione con termostato meccanico
- versione BRK35 con chiusura PUSH-PULL
- serie frigoriferi-freezer con compressore NextGen

Code chart  
Legenda codici

# VITRIFRIGO

COOL AND BEYOND



STAY TUNED



VITRI ALCESTE GROUP

**Vitrifrigo S.r.l.**

Vallefoglia (PU) - Italy

[www.vitrifrigo.com](http://www.vitrifrigo.com)



€ 15,00