

CHROMELOCK SERIES

VITRIFRIGO
COOL AND BEYOND



C62i CHR HP

Total volume Capacità totale	62 lt.
Freezer compartment Vano freezer	4,5 lt.
Net weight Peso netto	13,8 kg.
Power supply Alimentazione	12/24 Vdc
Absorption Consumo	214 Wh/24h



NextGen compressor
COMPRESSORE DI ULTIMA GENERAZIONE

R600a

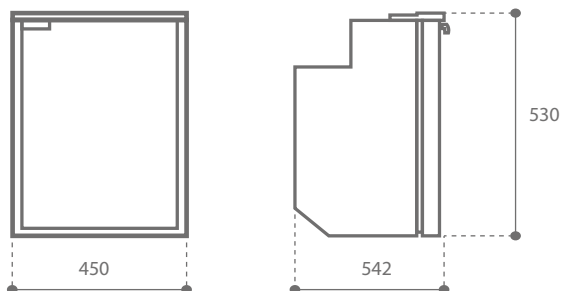

67%
LIGHTER

44%
IMPROVED
EFFICIENCY

40%
SMALLER

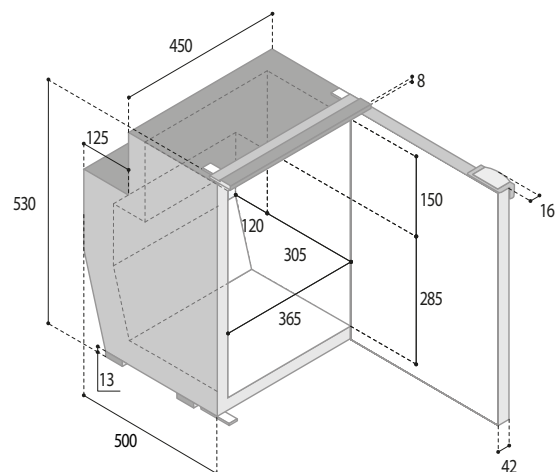

LED



Fridge
Freezer



Optional
**POWER
PACK**
115-230Vac

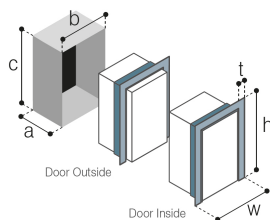

MOUNTING FLANGE
PROFILO DI FISSAGGIO

BUILT-IN
VANO INCASSO

DOOR	INSIDE	OUTSIDE
t:	25	25
w:	513	513
h:	542	542
a:	545	502
b:	468	468
c:	536	536



 **Door Inside**
PORTA A FILO INTERNO

 **Door Outside**
PORTA A FILO ESTERNO



INCREASED DOOR THICKNESS
ANTA A SPESSORE MAGGIORATO



ANTI-FINGERPRINT AND SCRATCH RESISTANT FINISH WITH SOFT TOUCH EFFECT
FINITURA ANTI IMPRONTA ED ANTIGRAFFIO CON EFFETTO SOFT TOUCH



REPLACEABLE SEAL
GUARNIZIONE SOSTITUIBILE



METAL FINISH HANDLE
MANIGLIA CON FINITURA METALLIZZATA



VENT POSITION SYSTEM
SISTEMA VENT POSITION



Double door colouring
DOPPIA COLORAZIONE DELLA PORTA



BLACK

LIGHT GREY



Replaceble finishing panel
PANNELLO DI FINITURA SOSTITUIBILE

